

Viral Systems - 2024

- **Viral Vector Engineering**
- **Transfection and packaging**
- **Virus production, purification, titration and transduction**
- **Upscaling production- Bioprocessing/Biomanufacture**
- **GMP compliance**

scientifix

Typical Experimental Workflow for Gene therapy/ Viral vector transfection/transduction:

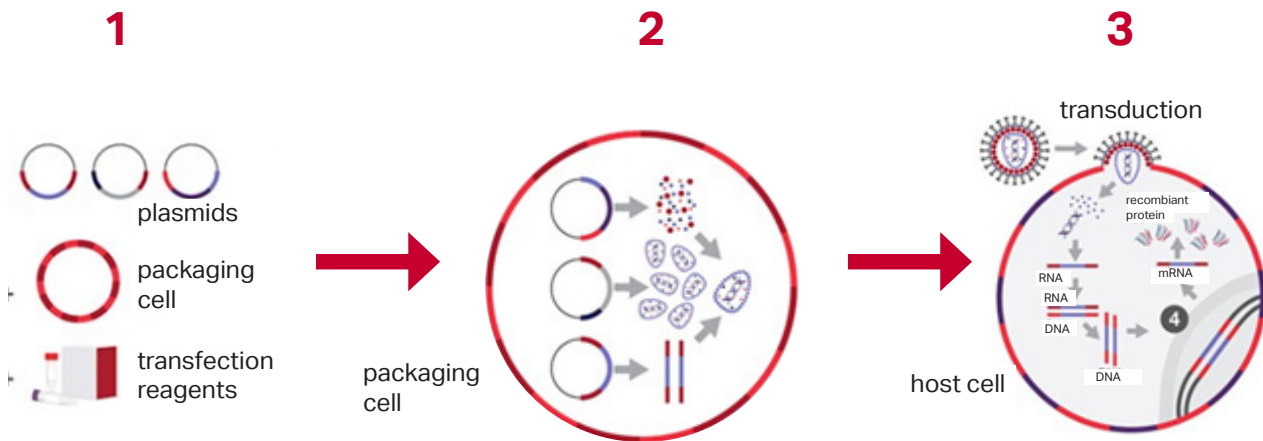

Step 1. Cloning and transfection:

The gene of interest is cloned into viral vector of choice. The clone is then co-transfected with plasmids encoding viral proteins allowing viral replication in a packaging cell line. A transfection reagent is also included.

Step 2. Viral Production:

Once inside the packaging cell line, all the plasmids are assembled to produce fully functional viruses. The viruses are then harvested, purified and the viral titre measured.

Step 3. Transduction:

Purified viral particles are introduced into host cells where the gene of interest is translated into protein.

Viral Vectors

There are four main types of viral vectors, each with their own unique characteristics, uses and limitations.

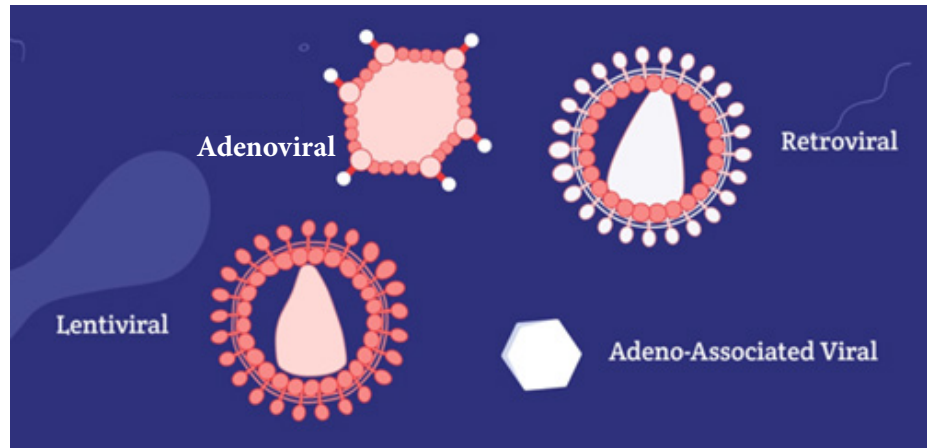

Adenovirus associated Virus (AAV)

- Typically deliver smaller DNA packages or genes
- Safe and efficient for in vivo gene therapy
- Non integrating, therefore can be used to target non dividing cells such as cells in the liver, nervous system, eyes, and skeletal muscles therefore persisting in patients for a prolonged period.
- Prior exposure to AAVs is common through natural infections, disqualifying 30-70% of patients from clinical trial participation and preexisting antibodies may attack or destroy the vector.

Adenoviral Vectors

- Like AAV vectors but larger vectors capable of delivering genetic material almost eight times the size of AAVs.
- Can cause strong immune responses, resulting in potential harmful inflammation.
- Latest vectors have been engineered to result in milder immune responses.

Lentiviral and Retroviral Vectors

- Carry larger genetic packages of RNA which is converted into DNA.
- Vector integrates into the genome of the target cells.
- Suitable for ex vivo treatment approaches.
- Central for Cell, Gene therapy and Immunotherapy treatments.

Choice for Virus

	AAV	Adenovirus	Lentivirus	Retrovirus
Broad host range (infects many cell types)	Yes	Yes	Yes	Yes (dividing cells only)
Infects both dividing and non-dividing cells	Yes	Yes	Yes	No (dividing cells only)
Genome Integration	No	No	Yes	Yes
Very high level of protein expression	No	Yes		
Size of wild-type genome	4.7kb	37.7kb	9.7kb	8.3kb
Insert-size capacity	2.5kb	3-8kb	2.5-5kb	2.5-5kb
Typical titre	>10 ¹⁰ genome copies/mL	10 ⁹ IFU/mL	10 ⁷ -10 ⁸ IFU/mL (depending on lenti vector)	10 ⁶ IFU/mL
Able to obtain high multiplicity of infection (>25 copies per cell)	Yes	Yes	No (up to 10 copies , integrated)	No (up to 10 copies integrated)

Cell-Type Specificity

	AAV	Adenovirus	Lentivirus	Retrovirus
Cell line (diving)	Yes	Yes	Yes	Yes
Primary cells (nondividing)	Yes	Yes	Yes	No
Primary cells (dividing)	Yes	Yes	Yes	Yes
Neuronal cells	Yes	Yes	Yes	No
Stem Cells	Yes	Yes	Yes	Yes
Hematopoietic cells	No	No	Yes (use RetroNectin reagent)	Yes (use RetroNectin reagent)

Cloning

In-Fusion

- Easy and accurate
- Seamless cloning without the use of ligase
- One quick reaction

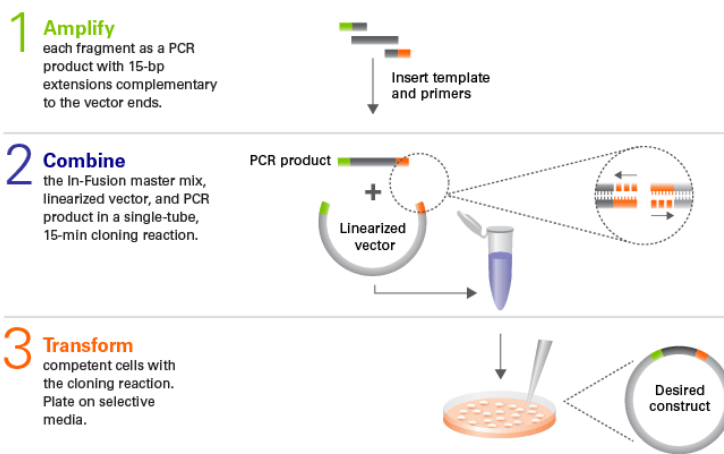

PRODUCT	SIZE	CODE
CLONING KITS		
In-Fusion Snap Assembly Starter Bundle (In-Fusion Snap Assembly Master Mix, NucleoSpin Gel and PCR Clean-Up kit, Stellar Competent Cells, PrimeSTAR Max DNA Polymerase)	10 Rxns	638945
In-Fusion Snap Assembly Value Bundle (In-Fusion Snap Assembly Master Mix, NucleoSpin Gel and PCR Clean-Up kit, Stellar Competent Cells, PrimeSTAR Max DNA Polymerase)	50 Rxns	638946
In-Fusion Snap Assembly Master Mix with Competent Cells	10 Rxns	638951
In-Fusion Snap Assembly Master Mix with Competent Cells	50 Rxns	638952
In-Fusion Snap Assembly EcoDry* Master Mix with Competent Cells	96 Rxns	638953
COMPETENT <i>E. coli</i>		
Stellar Competent Cells	10 x 100 uL	636763
Stellar Competent Cells (dam-/dcm-)	10 Transformations	636764
Stellar Electrocompetent Cells	10 Transformations	636765
Stellar Competent Cells	50 x 100 uL	636766
Stellar Competent Cells (96-well plate)	96 x 20 uL	636767
CLONING MASTERMIXES		
In-Fusion Snap Assembly Master Mix	500 Rxns	638943
In-Fusion Snap Assembly Master Mix	1,000 Rxns	638944
In-Fusion Snap Assembly Master Mix	10 Rxns	638947
In-Fusion Snap Assembly Master Mix	50 Rxns	638948
In-Fusion Snap Assembly Master Mix	250 Rxns	638949
In-Fusion Snap Assembly EcoDry* Master Mix	8 Rxns	638954
In-Fusion Snap Assembly EcoDry* Master Mix	32 Rxns	638955
In-Fusion Snap Assembly EcoDry* Master Mix	96 Rxns	638956

(*Ecodry - Lyophilized, dried pre-aliquoted cloning mix)



Plasmid purification- suitable for all



MACHEREY-NAGEL
www.mn-net.com

PRODUCT	SIZE	CODE
MINI Plasmid Preparation		
NucleoSpin Plasmid (NoLid)	50	740499.50
NucleoSpin Plasmid (NoLid)	250	740499.250
NucleoSpin Plasmid	50	740588.50
NucleoSpin Plasmid	250	740588.250
NucleoSpin Plasmid EasyPure	50	740727.50
NucleoSpin Plasmid EasyPure	250	740727.250
NucleoSpin Plasmid Transfection-grade	50	7400490.50
NucleoSpin Plasmid Transfection-grade	250	7400490.250



96 well plate Plasmid Preparation kits		
NucleoSpin Plasmid Transfection-grade	1 x 96 plate kit	740491.1
NucleoSpin Plasmid Transfection-grade	24 x 96 plate kit	740491.24
NucleoSpin Plasmid Transfection-grade	4 x 96 plate kit	740491.4
NucleoSpin Plasmid Transfection-grade.Core	24 x 96 plate kit	740492.24
NucleoSpin Plasmid Transfection-grade.Core	4 x 96 plate kit	740492.4
NucleoBond 96 Xtra Endotoxin Free	1 x 96 plate kit	740430.1
NucleoBond 96 Xtra Endotoxin Free	4 x 96 plate kit	740430.4

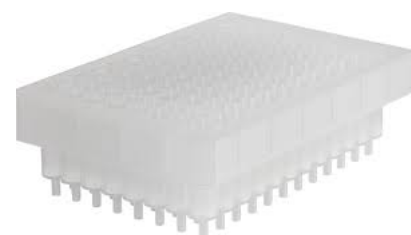

Midi/Maxi Plasmid Preparation		
NucleoBond Xtra Midi EF	10	740420.10
NucleoBond Xtra Midi EF	50	740420.50
NucleoBond Xtra Midi Plus EF	10	740422.10
NucleoBond Xtra Midi Plus EF	50	740422.50
NucleoBond Xtra Maxi EF	10	740424.10
NucleoBond Xtra Maxi EF	50	740424.50
NucleoBond Xtra Maxi Plus EF	10	740426.10
NucleoBond Xtra Maxi Plus EF	50	740426.50
NucleoBond Xtra Maxi Plus	10	740410.10
NucleoBond Xtra Maxi Plus	50	740410.50

Midi/Maxi Plasmid Preparation Endotoxin-Free		
NucleoBond Xtra Midi	10	740410.10
NucleoBond Xtra Midi	50	740410.50
NucleoBond Xtra Midi	100	740410.10
NucleoBond Xtra Midi Plus	10	740412.10
NucleoBond Xtra Midi Plus	50	740412.50
NucleoBond Xtra Maxi	10	740414.10
NucleoBond Xtra Maxi	50	740414.50
NucleoBond Xtra Maxi	100	740414.10
NucleoBond Xtra Maxi Plus	10	740416.10
NucleoBond Xtra Maxi Plus	50	740416.50

Plasmid purification- suitable for all



MACHEREY-NAGEL
www.mn-net.com

PRODUCT	SIZE	CODE
Mega/Giga Plasmid Preparation		
NucleoBond PC 2000 EF (Endotoxin Free), Mega kit	5 preps	740549
NucleoBond PC 2000, transfection-grade plasmid DNA, Mega kit	5 preps	740576
NucleoBond PC 10000 EF (Endotoxin Free), Giga kit	5 preps	740548
NucleoBond PC 10000, transfection-grade plasmid DNA, Giga kit	5 preps	740593
NucleoBond PC10000 Vaccum manifold (up to 5 columns)	1 piece	740599

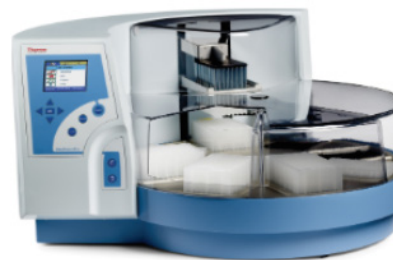
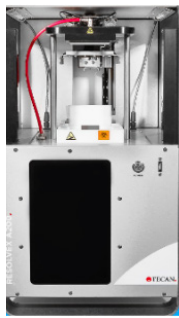
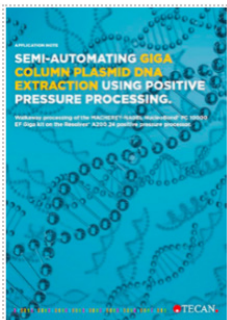

KingFisher Flex



Eppendorf epMotion 5075

Vacuum based purification



MACHEREY-NAGEL
www.mn-net.com



PRODUCT	SIZE	CODE
NucleoSnap Plasmid Mid	10	740494.10
NucleoSnap Plasmid Mid	50	740494.50
NucleoVac 24 Vaccum Manifold	1	740299

Plasmid DNA purification in Bioprocessing



NucleoBond RS- for large scale plasmid purification requiring high regulatory standards/vaccine grade

- Modular system for high-quality plasmid purification
- Endotoxin levels ≤ 0.01 EU/ μ g DNA
- Closed columns for pump or FPLC processing
- Scalable system for up to 200 mg of plasmid DNA
- High-quality plasmids as starting material for applications, like lentivirus/AAV production



PRODUCT	THEORECTICAL BINDING CAPACITY	CODE
NucleoBond RS 10	up to 10 mg	743502
NucleoBond RS 50	up to 50 mg	743503
NucleoBond RS 100	up to 100 mg	743504
NucleoBond RS 200	up to 200 mg	743505

Application data – Large-scale plasmid DNA purification

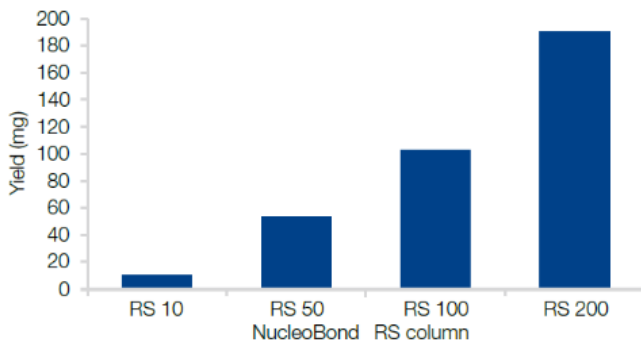

The NucleoBond RS purification workflow enables a straightforward scalability of your plasmid purification. Plasmid DNA was purified from E.coli with the four different sizes of our NucleoBond RS columns. The figure shows the maximum amounts of plasmid DNA achieved per column size.

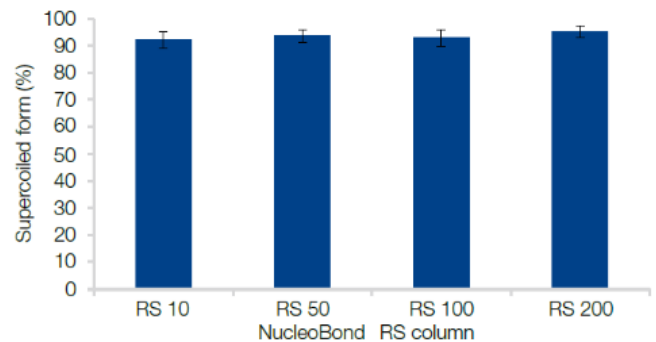

Plasmids isolated with NucleoBond RS columns show very high structural integrity. The supercoiled form of plasmid DNA is considered to be the desirable form for applications like gene therapy or vaccination. Regulatory standards specify that plasmids have to be present with more than 90 % supercoiled form. These data show that plasmids isolated with our NucleoBond RS columns meet these standards.

High Purity Bioprocessing Adsorbents for AAV



Novel nanofiber membrane to increase yield and purity suitable for Cell, Gene therapy and Vaccine production (Prepacked columns)

- High dynamic binding capacity
- 4 mg/mL, (4.7 kb) pDNA sequence
- Low operational back pressure due to open unobstructive flow path
- Suitable for large plasmids (tested up to 34 kB)
- Sanitizable with 0.5 M NaOH



PRODUCT	THEORETICAL BINDING CAPACITY	CODE
pDNAHERO® 1 polish	4 mg/cycle	PHP0001001A
pDNAHERO® 10 polish	40 mg/cycle	PHP0001001B

Virus Products



AAV Related Products

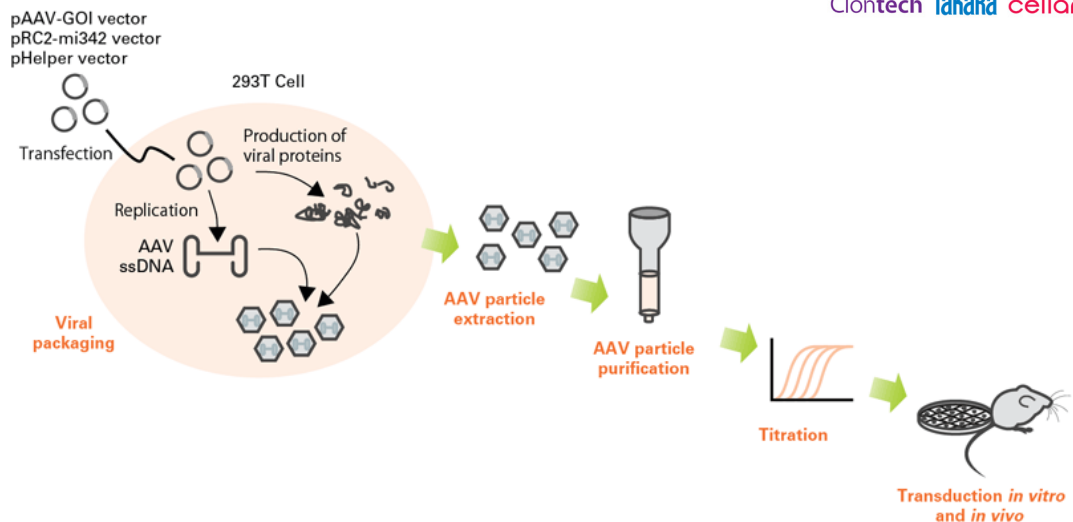

Vectors

Helper-free expression systems (CMV promoter)

PRODUCT	SIZE	CODE
AAVpro® Helper Free System (AAV1)	20 ug each	6673
AAVpro® Helper Free System (AAV2)	20 ug each	6230
AAVpro® Helper Free System (AAV5)	20 ug each	6650
AAVpro® Helper Free System (AAV6)	20 ug each	6651



Viral Delivery Systems



Clontech TakaRa cellartis

AAV2 tetracycline-inducible expression system

PRODUCT	SIZE	CODE
AAVpro® Tet-One™ Inducible Expression System (AAV2)	1 system	634310
Tet System Approved FBS	500 mL	631107
Tet System Approved FBS	500 mL	631106



AAV2 CRISPR/Cas9 system

PRODUCT	SIZE	CODE
AAVpro® CRISPR/Cas9 Vector System	1 system	632609
AAVpro® CRISPR/Cas9 Helper Free System (AAV2)	1 system	632608
AAVpro® CRISPR/SaCas9 Helper Free System (AAV2)	1 system	632619
AAVpro® CRISPR/SaCas9 Vector System	1 system	632618



AAVpro Helper Free Systems (AAV-CRE Recombinase)

PRODUCT	SIZE	CODE
AAVpro® Helper Free System (AAV1-CRE Recombinase)	20 ug each	6668
AAVpro® Helper Free System (AAV2-CRE Recombinase)	20 ug each	6652
AAVpro® Helper Free System (AAV5-CRE Recombinase)	20 ug each	6653
AAVpro® Helper Free System (AAV6-CRE Recombinase)	20 ug each	6654

AAVpro Helper Free Systems (AAV-CRE Recombinase)

PRODUCT	SIZE	CODE
AAVpro® Helper Free System (AAV1-LacZ)	20 ug each	6669
AAVpro® Helper Free System (AAV2-LacZ)	20 ug each	6655
AAVpro® Helper Free System (AAV5-LacZ)	20 ug each	6656
AAVpro® Helper Free System (AAV6-LacZ)	20 ug each	6657

pAAV-ZsGreen1 Vector

PRODUCT	SIZE	CODE
pAAV-ZsGreen1 Vector	20 ug	6231

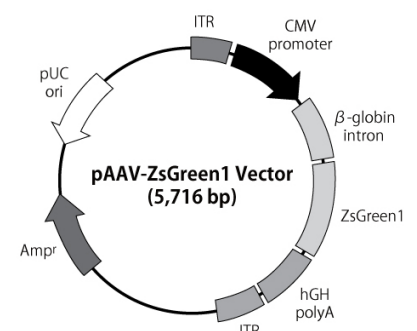
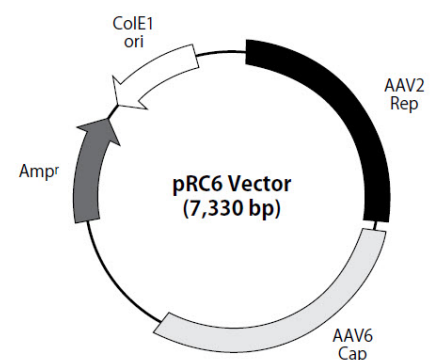

Transfection Reagents & Enhancers



Transfection Reagents

PRODUCT	SIZE	CODE
VirusGEN AAV Transfection kits	1 kit for 1L of cell culture	MIR 6750
VirusGEN AAV + RevIT for 1L Culture	1 kit for 1L of cell culture	MIR 8007
TransIT-VirusGEN Transfection Reagent	30 mL	MIR 6720
TransIT-VirusGEN Transfection Reagent	10x1.5 mL	MIR 6706
TransIT-VirusGEN Transfection Reagent	1.5 mL	MIR 6700
TransIT-VirusGEN Transfection Reagent	0.75 mL	MIR 6704
TransIT-VirusGEN Transfection Reagent	0.30 mL	MIR 6703
TransIT-VirusGEN Transfection Reagent	5x 1.5 mL	MIR 6705
VirusGEN AAV + RevIT for 10L Culture	1 kit for 10L of cell culture	MIR 8008
TransIT-VirusGEN	0.30 mL	MIR 6703
TransIT-VirusGEN Transfection Reagent	5x 1.5 mL	MIR 6705



Transfection Enhancer for AAV

Designed to deliver 2-4X higher AAV titer for

- any serotype
- any cell line
- any transfection reagent
- any media

PRODUCT	SIZE	CODE
RevIT™	1.5 mL	MIR 8000
RevIT™	10 X 1.5 mL (10 L of cell culture)	MIR 8006
VirusGEN AAV kit + RevIT™	1L Culture	MIR 8007
VirusGEN AAV kit + RevIT™	10 x L Culture	MIR 8008



Packaging Systems and Cells



293T cells for AAV production

PRODUCT	SIZE	CODE
AAVpro® 293T Cell Line	1 mL	632273

AAVpro packaging plasmid sets

PRODUCT	SIZE	CODE
AAVpro® Packaging Plasmid (AAV1)	1 mg each	6672
AAVpro® Packaging Plasmid (AAV2)	1 mg each	6234
AAVpro® Packaging Plasmid (AAV5)	1 mg each	6664
AAVpro® Packaging Plasmid (AAV6)	1 mg each	6665



Extraction and Purification Kits



AAVpro® Extraction kits

PRODUCT	SIZE	CODE
AAVpro® Extraction Solution	1 set	6235
AAVpro® Cell & Sup. Extraction/Concentration Pack Maxi (All Serotypes)	1 Kit(5 X T225 flasks)	6677
AAVpro® Freeze-Thaw Extraction Buffer (All Serotypes)	2 x 20 mL	6679
AAVpro® Helper Free System (AAV6-LacZ)	20 ug each	6657



AAVpro® purification kits

PRODUCT	SIZE	CODE
AAV purification Kit Maxi (All Serotypes)	4 preps (5 X T225 flasks/prep)	6666
AAV purification Kit Midi (All Serotypes)	4 preps (1 X T225 flasks/prep)	6675
AAVpro® Cell & Sup. Purification Kit Maxi (All Serotypes)	4 preps (5 X T225 flasks/prep)	6676
AAVpro® Purification Kit (AAV2)	2 preps	6232
AAVpro® Purification Pack Maxi (All Serotypes)	4 preps (5 X T225 flasks/prep)	6678



AAVpro® Titration kits (for Real Time PCR)

AAVpro® Titration kits (for Real Time PCR)	100 Rxns	6233
--	----------	------



AAVpro® Concentrator Kit

AAVpro® Concentrator	1 kit (up to 150 mL of culture supernatant)	6674
----------------------	---	------



Adeno Virus Related Products



Adeno-X adenoviral system 3

PRODUCT	SIZE	CODE
Adeno-X™ Adenoviral System 3 (CMV)	10 Rxns	632269
Adeno-X™ Adenoviral System 3 (CMV, Green)	10 Rxns	632267
Adeno-X™ Adenoviral System 3 (CMV, Red)	10 Rxns	632268
Adeno-X™ Adenoviral System 3 (Universal)	10 Rxns	632266
Adeno-X™ Adenoviral System 3 (Universal, Red)	10 Rxns	632265
Adeno-X™ Adenoviral System 3 (Universal, Green)	10 Rxns	632264
Adeno-X™ Adenoviral System 3 (Tet-On® 3G Inducible)	10 Rxns	631180



Tetracycline-inducible adenovirus system

PRODUCT	SIZE	CODE
Adeno-X™ Adenoviral System 3 (Tet-On® 3G Inducible)	10 Rxns	631180
Tet System Approved FBS	50 mL	631107
Tet System Approved FBS	500 mL	631106



Packaging Cell

293 cells for adeno-viral packaging 293 cells for adenoviral packaging Link

PRODUCT	SIZE	CODE
Adeno-X™ 293 Cell Line	Each	632271

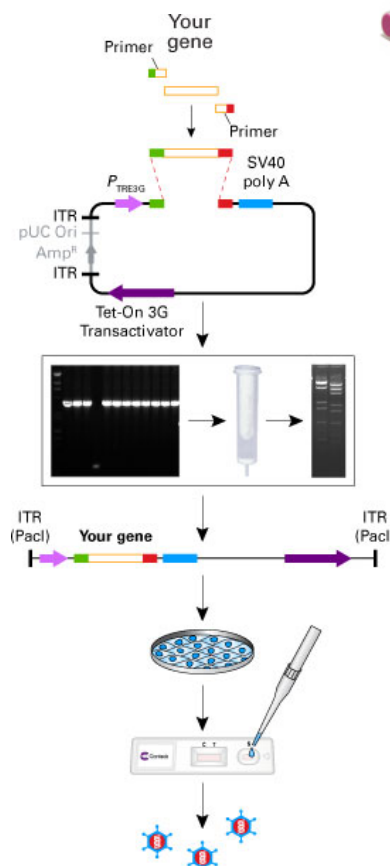

Lentivirus



Clontech TAKARA cellartis

Lentiviral and Retroviral Vectors

- Carry larger genetic packages of RNA which is converted into DNA.
- Vector integrates into the genome of the target cells.
- Best suited for dividing cells
- Suitable for ex vivo treatment approaches. Cells are removed from body, cultured and allowed to replicate and expand. Cells are then treated with vectors containing new genetic instructions such as a working gene. The modified cells are returned to the body where they divide. Due to the integration these new cells can continue to grow and function.

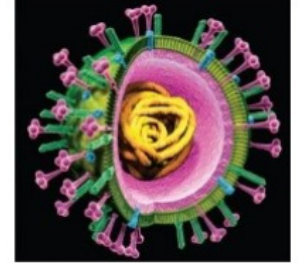

Constitutive gene expression

PRODUCT	SIZE	CODE
Lenti-X™ Bicistronic Expression System (Puro)	Each	632183
Lenti-X™ Bicistronic Expression System (Hyg)	Each	632182
Lenti-X™ Bicistronic Expression System (Neo)	Each	632181
Lenti-X™ Expression System	Each	632164

EF-1 alpha promoter Vectors

PRODUCT	SIZE	CODE
pLVX-EF1alpha-DsRed-Monimer-C1	10 ug	631989
pLVX-EF1alpha-mCherry-N1	10 ug	631986
pLVX-EF1alpha-mCherry-C1	10 ug	631985
pLVX-EF1alpha-AcGFP1-C1	10 ug	631984
pLVX-EF1alpha-AcGFP1-N1	10 ug	631983
pLVX-EF1alpha-IRES-ZsGreen1	10 ug	631982
Lenti-X™ Expression System (EF1alpha Version)	Each	631253



IRES Vectors

PRODUCT	SIZE	CODE
pLVX-IRES-tdTomato Vector	20 ug	631238
pLVX-IRES-mCherry Vector	20 ug	631237
pLVX-EF1alpha-IRES-mCherry	10 ug	631987

Tet-One inducible expression systems

PRODUCT	SIZE	CODE
Lenti-X™ Tet-One™ Inducible Expression System (Puro)	Each	631847
Lenti-X™ Tet-One™ Inducible Expression System	Each	631844
Tet System Approved FBS	50 mL	631107
Tet System Approved FBS	500 mL	631106

Tet-On® 3G Inducible expression System

PRODUCT	SIZE	CODE
Lenti-X™ Tet-On® 3G Inducible Expression System (EF1alpha Version)	Each	631363
Lenti-X™ Tet-On® 3G Inducible Expression System (EF1alpha, Bicistronic)	Each	631354
Lenti-X™ Tet-On® 3G Inducible Expression System (EF1alpha,ZsGreen1)	Each	631353
Lenti-X™ Tet-On® 3G Inducible Expression System (EF1alpha,mCherry)	Each	631352
Lenti-X™ Tet-On® 3G Inducible Expression System (Bicistronic Version)	Each	631351
Lenti-X™ Tet-On® 3G Inducible Expression System (with ZsGreen1)	Each	631350
Lenti-X™ Tet-On® 3G Inducible Expression System (with mCherry)	Each	631349
Lenti-X™ Tet-On® 3G Inducible Expression System	Each	631187

Transfection Reagents



Lentivirus Production

PRODUCT	SIZE	CODE
Lentivirus Packaging Mix	34 rxn	MIR 6640
Lentivirus Packaging Mix	5 rxn	MIR 6630
TransIT Lentivirus System	34 rxn	MIR 6655
TransIT Lentivirus System	5 rxn	MIR 6650
TransIT Lenti	10 x 1.5 mL	MIR 6606
TransIT Lenti	5 x 1.5 mL	MIR 6605
TransIT Lenti	1.5 mL	MIR 6600
TransIT Lenti	0.3 mL	MIR6603
TransduceIT Transfection Reagent	0.75 mL	MIR6604

Packaging Systems/ Cells



Lentivirus Packaging Systems

PRODUCT	SIZE	CODE
Lenti-X™ Packaging Single Shots (VSV-G)	16 Rxns	631275
Lenti-X™ Packaging Single Shots (Integrase Deficient)	16 Rxns	631277
Lenti-X™ Packaging Single Shots (VSV-G)	96 Rxns	631276
Lenti-X™ Packaging Single Shots (96-well, VSV-G)	4 x 96 well plates	631282
Lenti-X™ Packaging Single Shots (Envelope-Free)	16 Rxns	631294
Lenti-X™ 293T Cell Line	1 mL	632180



Titration Kits



Lentivirus Titration kits

PRODUCT	SIZE	CODE
Lenti-X™ GoStix™ Plus	20 tests	631280
Lenti-X™ GoStix™ Plus	50 tests	631281
Lenti-X™ qRT-PCR Titration Kit	200 Rxns	631235
Lenti-X™ p24 Rapid Titer Kit(Single Wash)	96 Rxns	631476
Lenti-X™ p24 Rapid Titer Kit	96 Rxns	632200
Lenti-X Provirus Quantification Kit	200 Rxns	631239



Concentrator Kits



PRODUCT	SIZE	CODE
Lenti-X™ Concentrator	500 mL	631232
Lenti-X™ Concentrator	100 mL	631231

Purification Kits



PRODUCT	SIZE	CODE
Lenti-X™ Maxi purification kit	5 preps	631234
Lenti-X™ Maxi purification kit	2 preps	631233

Premade Lenti Particles



Whole-Cell Labeling (fluorescent Lenti particles)

PRODUCT	SIZE	CODE
rLV.EF1.ZsYellow1-9	1 x 20 uL	0040VCT
rLV.EF1.AmCyan1-9	1 x 20 uL	0039VCT
rLV.EF1.ZsGreen1-9	1 x 20 uL	0038VCT
rLV.EF1.mCherry-9	1 x 20 uL	0037VCT
rLV.EF1.tdTomato-9	1 x 20 uL	0036VCT
rLV.EF1.ZsYellow1-9	3 x 20 uL	0012VCT
rLV.EF1.AmCyan1-9	3 x 20 uL	0011VCT
rLV.EF1.ZsGreen1-9	3 x 20 uL	0010VCT
rLV.EF1.mCherry-9	3 x 20 uL	0009VCT
rLV.EF1.tdTomato-9	3 x 20 uL	0008VCT

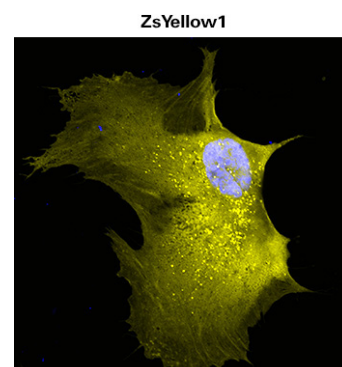

Specific Subcellular Organelle Labelling (fluorescent Lenti particles)

PRODUCT	SIZE	CODE
rLV.EF1.mCherry-ER-9	3 x 20 uL	0025VCT
rLV.EF1.mCherry-Mito-9	3 x 20 uL	0024VCT
rLV.EF1.mCherry-Nuc-9	3 x 20 uL	0023VCT
rLV.EF1.mCherry-Golgi-9	3 x 20 uL	0022VCT
rLV.EF1.mCherry-Tubulin-9	3 x 20 uL	0021VCT
rLV.EF1.mCherry-Actin-9	3 x 20 uL	0020VCT
rLV.EF1.AcGFP1-Mem-9	3 x 20 uL	0019VCT
rLV.EF1.AcGFP1-Endo-9	3 x 20 uL	0018VCT
rLV.EF1.AcGFP1-Mito-9	3 x 20 uL	0017VCT
rLV.EF1.AcGFP1-Nuc-9	3 x 20 uL	0016VCT
rLV.EF1.AcGFP1-Golgi-9	3 x 20 uL	0015VCT
rLV.EF1.AcGFP1-Tubulin-9	3 x 20 uL	0014VCT
rLV.EF1.AcGFP1-Actin-9	3 x 20 uL	0013VCT

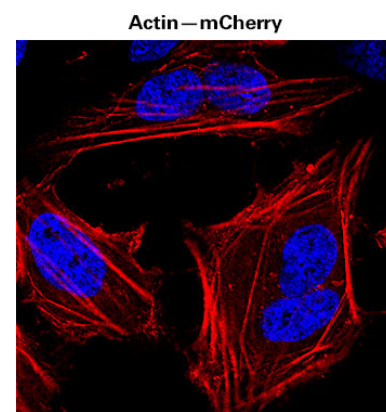

Premade Lenti Particles



Tet-On 3G transactivator lentiviral particles

PRODUCT	SIZE	CODE
rLV.EF1.Tet3G-9	1 x 20 u	0055VCT
rLV.EF1.Tet3G-9	3 x 20 uL	0027VCT
Tet System Approved FBS	50 mL	631107
Tet System Approved FBS	500 mL	631106

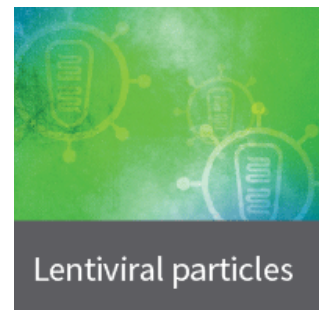

Transduction Enhancers



Lentiviral Transduction Enhancers

PRODUCT	SIZE	CODE
Lenti-X™ Accelerator	1 mL	631257
Lenti-X™ Accelerator	0.4 mL	631256
Lenti-X™ Accelerator Starter Kit	Each	631254
Ecotropic Receptor Booster	20 Rxns	631471
Retro-X™ Universal Packaging System	Each	631530

Transduction Reagent



TransducelT™ Reagent is a cationic polymer, shown to greatly enhance retroviral transduction and transgene expression in both dividing and quiescent mammalian cells

Lentiviral Transduction Enhancers

PRODUCT	SIZE	CODE
TransducelT Transduction Reagent	1 mL	MIR 6620

Hematopoietic and Stem Cell Transduction Enhancer



RetroNectin

RetroNectin reagent is a fragment of recombinant human fibronectin fragment that enhances and promotes colocalization of lentivirus/retrovirus with target hematopoietic cells

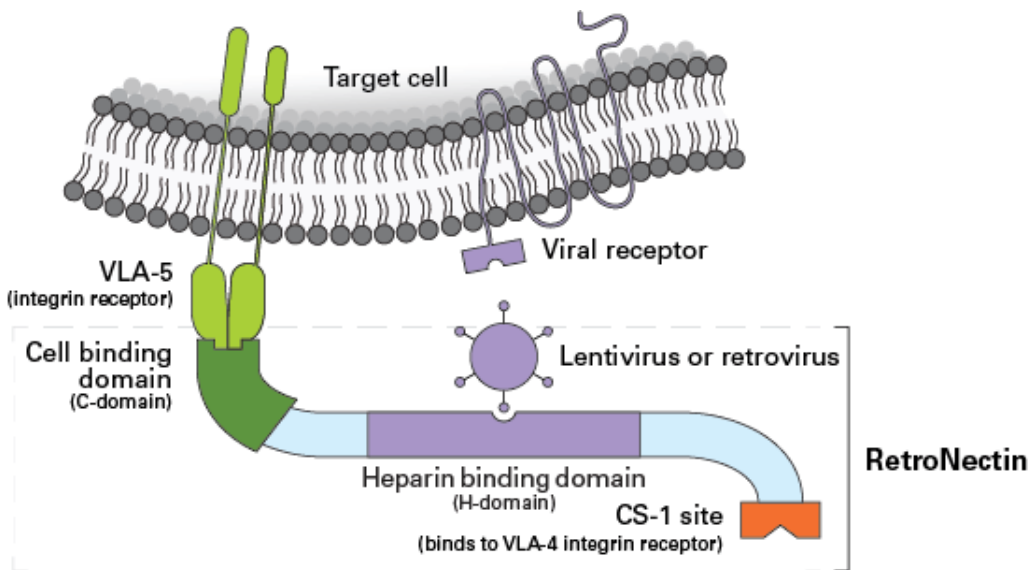

RetroNectin®- Transduction enhancer

PRODUCT	SIZE	CODE
RetroNectin® Precoated Dish	10 Dishes	T110A
RetroNectin® Recombinant Human Fibronectin Fragment	2.5 mg	T100B
RetroNectin® Recombinant Human Fibronectin Fragment	0.5 mg	T100A
RetroNectin® GMP grade	2.5 mL	T202

Lentiviral Purifications



LentiHERO®

- large binding surface area
- fast flow rates
- high capacity
- mild processing conditions
- high recovery
- good yield
- functional lentivirus
- from laboratory scale to development scale

PRODUCT	SIZE	Binding Capacity (viral particles.mL)	CODE
LentiHERO® 1	1 mL	4.5E11 (adherent feedstock); 1.72e12 (suspension feedstock)	LH0002001A
LentiHERO® 10	10 mL	4.5e12 (adherent feedstock); 1.72e13 (suspension feedstock)	LH0010001B
Nereus Spin Column	2 columns	4.7e10 lentiviral particles/unit	NL100100

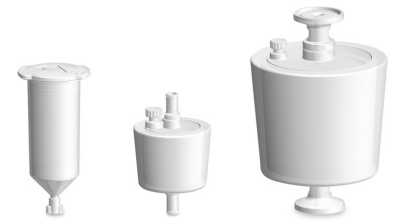

Retrovirus



Constitutive Promoter

PRODUCT	SIZE	CODE
Retro-X™ Q Vector Set	4 x 20 ug	631516
pQCXIX Retroviral Vector	20 ug	631515
pQCXIN Retroviral Vector	20 ug	631514
LRCX Retroviral Vector Set	Each	631511
pLXSN Retroviral Vector	20 ug	631509
pLNCX2 Retroviral Vector	20 ug	631503
pLXIN Retroviral Vector	20 ug	631501
pDON-5 DNA	20 ug	3658
pDON-5 Neo DNA	20 ug	3657
pMEI-5 DNA	20 ug	3656
pMEI-5 Neo DNA	20 ug	3655
pDON-AI-2 DNA	20 ug	3654
pDON-AI-2 Neo DNA	20 ug	3653

Flourescent Protein Vectors

PRODUCT	SIZE	CODE
pRetroQ-mCherry-N1 Vector	10 ug	632568
pRetroQ-mCherry-C1 Vector	10 ug	632567
pRetroX-IRES-DsredExpress Vector	20 ug	632521
pRetroX-IRES-ZsGreen1 Vector	20 ug	632520
pRetroQ-DsRed Monomer-C1 Vector	20 ug	632508
pRetroQ-DsRed Monomer-N1 Vector	20 ug	632507
pRetroQ-AcGFP1-C1 Vector	20 ug	632506
pRetroQ-AcGFP1-N1 Vector	20 ug	632505

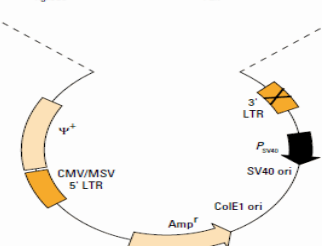
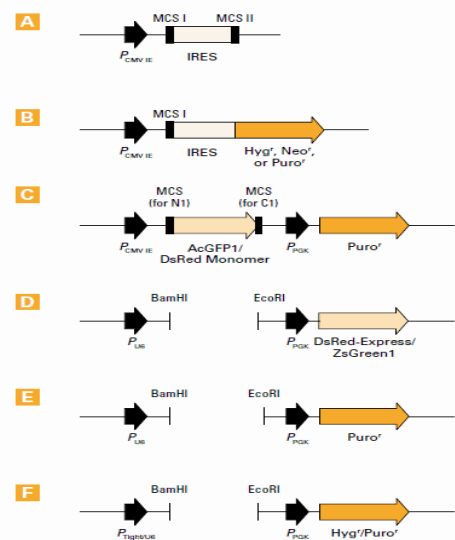
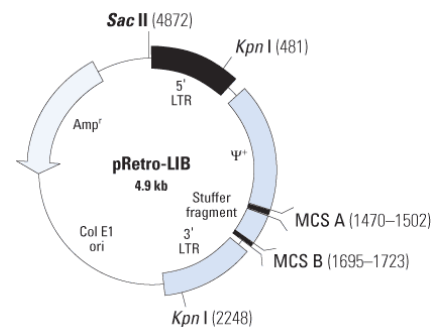

Retrovirus



Clontech TAKARA cellartis

Retro-X Tet-One Inducible expression systems

PRODUCT	SIZE	CODE
Retro-X™ Tet-One™ Inducible Expression System (Puro)	Each	634307
Tet System Approved FBS	50 mL	631107
Tet System Approved FBS	500 mL	631106

Retro-X Tet-On® 3G Inducible expression systems

Retro-X™ Tet-On® 3G Inducible Expression System	Each	631188
---	------	--------

Pluripotent cell lines/Stem Cell

MSCV system

PRODUCT	SIZE	CODE
MSCV Retroviral Expression System	Each	634401

Retrovirus Packaging Systems/ Cells

PRODUCT	SIZE	CODE
Retro-X™ Universal Packaging System	Each	631530
Pantropic Retroviral Expression System	Each	631512
RetroPack™ PT67 Cell Line	1 mL	631510
Retro-X™ System	Each	631508

Retrovirus Titration Kits (for real Time PCR)

PRODUCT	SIZE	CODE
Retro-X™ qRT-PCR Titration Kit	200 Rxns	631453

Retrovirus Concentrator Kit

PRODUCT	SIZE	CODE
Retro-X™ Concentrator	500 mL	631456

Retrovirus Integration Kit

PRODUCT	SIZE	CODE
Retro-X™ Integration Site Analysis Kit	Each	631467

Transduction Enhancer Kit

PRODUCT	SIZE	CODE
Ecotropic Receptor Booster	20 Rxns	631471

Hematopoietic and Stem Cell Transduction Enhancer

PRODUCT	SIZE	CODE
RetroNectin® Precoated Dish	10 Dishes	T110A
RetroNectin® Recombinant Human Fibronectin Fragment	2.5 mg	T100B
RetroNectin® Recombinant Human Fibronectin Fragment	0.5 mg	T100A
RetroNectin® GMP grade	2.5 mL	T202

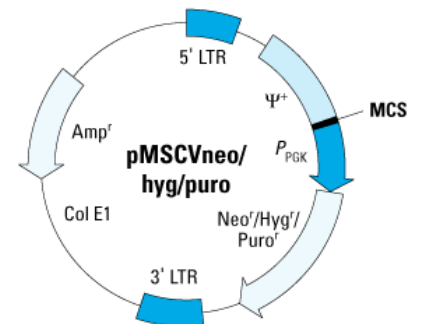
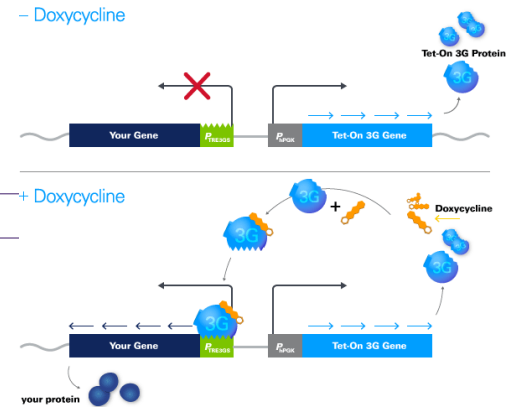

Viral DNA and RNA Purification



MACHERY-NAGEL
www.mn-net.com

RNA/DNA-Virus Isolation for Enzymatic reactions and RT-PCR

PRODUCT	SIZE	CODE
NucleoSpin RNA virus mini kit	50 preps	740956.50
NucleoSpin RNA virus midi kit	25 preps	740958
NucleoSpin RNA/DNA virus mini kit	50 preps	740983.50
NucleoSpin 96 Virus Core Kit for RNA/DNA purification-automation	384(4 x 96-well plates)	740452.4
NucleoSpin 96 Virus Core Kit for RNA/DNA purification- automation	384(2 or 4 x 96-well plates)	740691.40
NucleoSpin 8 Virus Core Kit, 8-well kit for RNA/DNA purification- automation	96 Preps (8-well strips)	740643
NucleoSpin 8 Virus Core Kit, 8-well kit for RNA/DNA purification- automation	384 Preps (8-well strips)	740451.4
NucleoSpin RNA Virus for Qiacube- automation	240 preps	740956.240C
NucleoMag Virus kit for RNA/DNA purification- automation	384 Preps	744800.4

Commercial Manufacture/ Bioprocessing for Cell & Gene Therapy and Immunotherapy



GMP Transfection Reagents and Kits

TransIT-VirusGEN® GMP transfection Reagents and Kits

1. Achieve higher titers (2-10x) and higher percent full AAV capsids
2. >50% savings on a cost per dose basis vs. the leading competitor
3. Universally platformable across all AAV serotypes

PRODUCT	SIZE	CODE
VirusGEN GMP transfection Reagent	150 mL	MIR 6845-GMP
VirusGEN GMP LV transfection Reagent	Pls inquire	MIR 6825-GMP
VirusGEN GMP AAV transfection Reagent	Pls inquire	MIR 6815-GMP



Talk to us for solutions on:

- unlocking value with highly efficient DSP
 - reducing FTE costs
 - reducing QC costs

High Purity Bioprocessing Adsorbents



A range of adsorbents from viral capture, Host Protein removal to polishing the final viral product by separating the empty capsids from full capsids is available from Astrea Bioseparations.

SP PuraBead®

- Hydrophobic Interaction Chromatography
- Viral capture/purification based on hydrophobicity.
- Manufactured to ISO 9001 standards.
- Available in bulk volumes suitable for GMP processes.

CAPTURE	INTERMEDIATE POLISH	EMPTY & FULL CAPSID SEPARATION
Capture with SP Purabead® P60 HF	Remove host cell contamination with HCPure®	Resolve capsids with Q Purabead® P6 HF
>70% recovery of AAV and AAV 9 capsids	>90% recovery of AAV2 capsids	>70% recovery of AAV 8 capsids
	>80% of HEK 293 host cell contamination removed	

PRODUCT	SIZE	CODE
Butyl PuraBead® HF	100mL	3416-00100
Butyl PuraBead® HF	1L	3416-01000
Butyl PuraBead® HF	25mL	3416-00025
Butyl PuraBead® HF	500mL	3416-00500
Butyl PuraBead® HF Pre-packed Column	Pre-packed Column - 1 x 1 mL	6734
Butyl PuraBead® HF Pre-packed Column	Pre-packed Column - 1 x 5 mL	6735
Butyl PuraBead® HF Pre-packed Column	Pre-packed Column - 4 x 1 mL	6634
Butyl PuraBead® HF Pre-packed Column	Pre-packed Column - 4 x 5 mL	6635
Hexyl PuraBead® HF	100mL	3426-00100
Hexyl PuraBead® HF	1L	3426-01000
Hexyl PuraBead® HF	25mL	3426-00025
Hexyl PuraBead® HF	500mL	3426-00500
Hexyl PuraBead® HF Pre-packed Column	Pre-packed Column - 1 x 1 mL	6736
Hexyl PuraBead® HF Pre-packed Column	Hexyl PuraBead® HF Pre-packed Column - 1 x 5 mL	6737
Hexyl PuraBead® HF Pre-packed Column	Pre-packed Column - 4 x 1 mL	6636
Hexyl PuraBead® HF Pre-packed Column	Pre-packed Column - 4 x 5 mL	6637
HIC Selection Kit	4 x 1 mL	6614
HIC Selection Kit	4 x 5 mL	6615
Octyl PuraBead® HF	100mL	3455-00100
Octyl PuraBead® HF	1L	3455-01000
Octyl PuraBead® HF	25mL	3455-00025
Octyl PuraBead® HF	500mL	3455-00500
Octyl PuraBead® HF Pre-Packed Column	Pre-Packed Column - 1 x 1 mL	6712
Octyl PuraBead® HF Pre-Packed Column	Pre-Packed Column - 1 x 5 mL	6713
Octyl PuraBead® HF Pre-Packed Column	Pre-Packed Column - 4 x 1 mL	6612

NucleoBond RS



MACHEREY-NAGEL
www.mn-net.com

NucleoBond RS- for large scale plasmid purification requiring high regulatory standards/vaccine grade

- Modular system for high-quality plasmid purification
- Endotoxin levels ≤ 0.01 EU/ μ g DNA
- Closed columns for pump or FPLC processing
- Scalable system for up to 200 mg of plasmid DNA
- High-quality plasmids as starting material for applications, like lentivirus/AAV production

	THEORETICAL BINDING CAPACITY	CODE
NucleoBond RS 10	up to 10 mg	743502
NucleoBond RS 50	up to 50 mg	743503
NucleoBond RS 100	up to 100 mg	743504
NucleoBond RS 200	up to 200 mg	743505

LentiHERO



LentiHERO®

- large binding surface area
- fast flow rates
- high capacity
- mild processing conditions
- high recovery
- good yield
- functional lentivirus
- from laboratory scale to development scale

PRODUCT	SIZE	Binding Capacity (viral particles.mL)	CODE
LentiHERO® 1	1 mL	4.5E11 (adherent feedstock); 1.72e12 (suspension feedstock)	LH0002001A
LentiHERO® 10	10 mL	4.5e12 (adherent feedstock); 1.72e13 (suspension feedstock)	LH0010001B
Nereus Spin Column	2 columns	4.7e10 lentiviral particles/unit	NL100100



Intermediate Polish - Host Protein Removal



HCPure™

Mixed mode chromatography adsorbent removal of

- Host cell proteins
- Light chain IgG
- HMW aggregates

PRODUCT	SIZE	CODE
HCPure™	25 mL	3260-00025
HCPure™	100 mL	3260-00100
HCPure™	500 mL	3260-00500
HCPure™	1L	3260-01000



Novel nanofiber membrane to increase yield and purity suitable for Cell, Gene therapy and Vaccine production (Prepacked columns)

- High dynamic binding capacity
- 4 mg/mL, (4.7 kb) pDNA sequence
- Low operational back pressure due to open unobstructive flow path
- Suitable for large plasmids (tested up to 34 kB)
- Sanitizable with 0.5 M NaOH

	THEORETICAL BINDING CAPACITY	CODE
pDNAHERO® 1 polish	4 mg/cycle	PHP0001001A
pDNAHERO® 10 polish	40 mg/cycle	PHP0001001B

Empty and Full Capsid Separation

Q PuraBead®

Ion Exchange Chromatography range

- Separates Empty from Full Viral Capsids

PRODUCT	SIZE	CODE
CM PuraBead® HF Pre-packed Columns	1 x 1 mL	6706
CM PuraBead® HF Pre-packed Columns	1 x 5 mL	6707
CM PuraBead® HF Pre-packed Column	4 x 1 mL	6606
CM PuraBead® HF Pre-packed Columns	4 x 5 mL	6607
CM PuraBead® P6HF	1L	3450-01000
CM PuraBead® P6HF	100 mL	3450-00100
CM PuraBead® P6HF	25 mL	3450-00025
CM PuraBead® P6HF	500 mL	3450-00500
DEAE PuraBead® HF	100 mL	3451-00100
DEAE PuraBead® HF	1L	3451-01000
DEAE PuraBead® HF	25 mL	3451-00025
DEAE PuraBead® HF	500 mL	3451-00500
DEAE PuraBead® HF Pre-packed Column	1 x 1 mL	6702
DEAE PuraBead® HF Pre-packed Columns	1 x 5 mL	6703
DEAE PuraBead® HF Pre-packed Columns	4 x 1 mL	6602
DEAE PuraBead® HF Pre-packed Columns	4 x 5 mL	6603
IEX Selection Kit	4 x 1 mL	6608
IEX Selection Kit	4 x 5 mL	6609
Q PuraBead® HF	100 mL	3452-00100
Q PuraBead® HF	1L	3452-01000
Q PuraBead® HF	25 mL	3452-00025
Q PuraBead® HF	500 mL	3452-00500
Q PuraBead® HF Pre-packed Columns	1 x 1 mL	6700
Q PuraBead® HF Pre-packed Columns	1 x 5 mL	6701
Q PuraBead® HF Pre-packed Columns	1 x 5 mL	6600



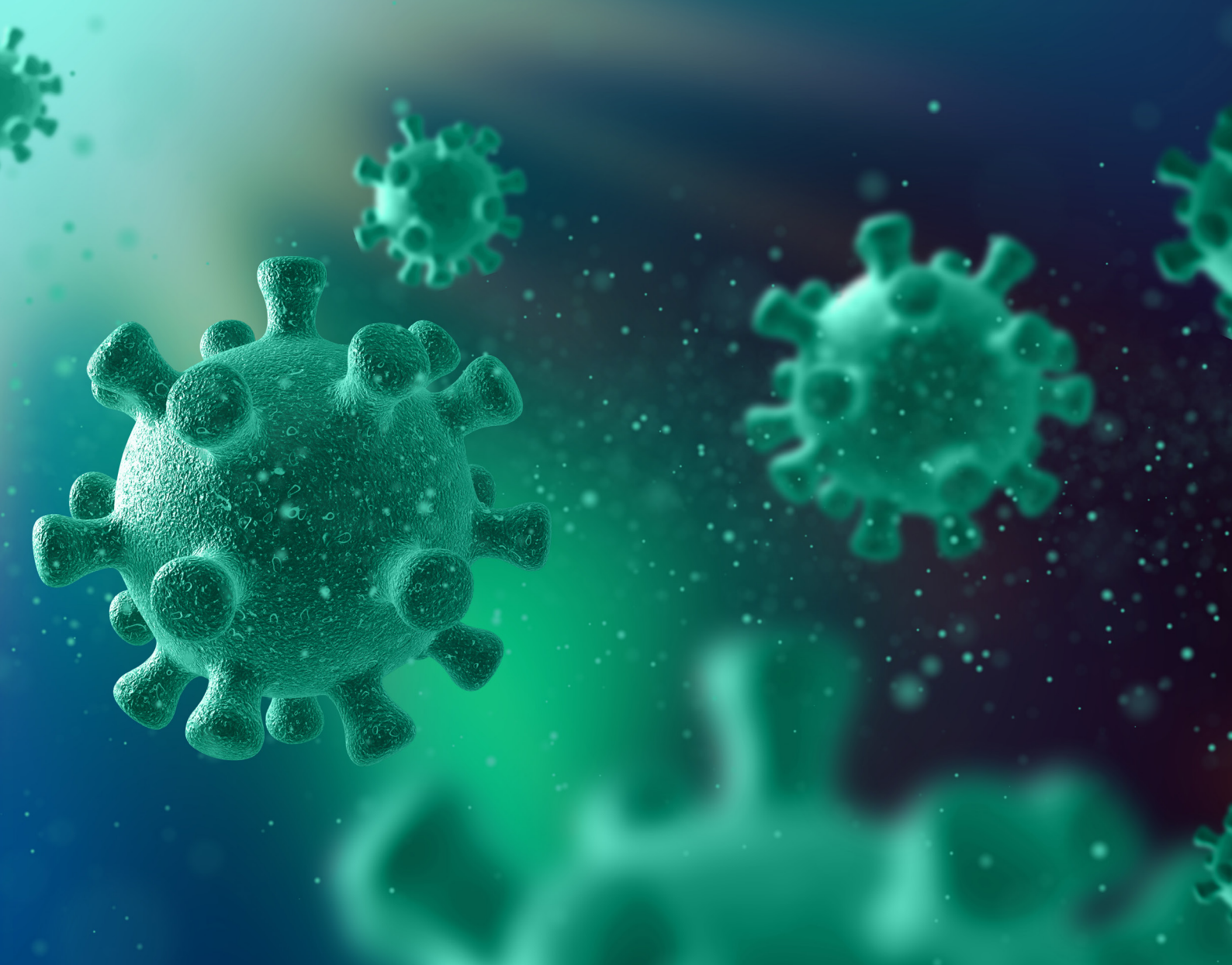

Please contact Scientifix for more product information, pricing or to request a quote
For customer service, call 1800 007 900 or email info@scientifix.com.au
More information visit www.scientifix.com.au

scientifix



RNA/DNA-Virus Isolation for Enzymatic reactions and RT-PCR				
PRODUCT	SIZE	CODE	LIST PRICE	PROMO PRICE
NucleoSpin RNA virus mini kit	50 preps	740956.50	\$ 587	\$ 352
NucleoSpin RNA virus mini kit	250 preps	740956.250	\$ 2,642	\$ 1,585
NucleoSpin RNA virus midi kit	25 preps	740958	\$ 843	\$ 506
NucleoSpin RNA/DNA virus mini kit	50 preps	740983.50	\$ 662	\$ 397
NucleoSpin RNA/DNA virus mini kit	250 preps	740983.250	\$ 2,962	\$ 1,777
NucleoSpin 96 Virus Core Kit for RNA/DNA purification	384(4 x 96-well plates)	740452.4	\$ 3,080	\$ 1,848
NucleoSpin 96 Virus Core Kit for RNA/DNA purification	384(2 or 4 x 96-well plates)	740691.4	\$ 4,172	\$ 2,503
NucleoSpin 8 Virus Core Kit, 8-well kit for RNA/DNA purification	96 Preps (8-well strips)	740643	\$ 1,187	\$ 712
NucleoSpin 8 Virus Core Kit, 8-well kit for RNA/DNA purification	384 Preps (8-well strips)	740451.4	\$ 3,080	\$ 1,848
NucleoSpin RNA Virus for Qiacube	240 preps	740956.240C	\$ 2,642	\$ 1,585
NucleoMag Virus kit for RNA/DNA purification	384 Preps	744800.4	\$ 2,867	\$ 1,720
NucleoMag Pathogen	1 x 96 plate kit	744210.1	\$ 1,135	\$ 681
NucleoMag Pathogen	4 x 96 plate kit	744210.4	\$ 3,929	\$ 2,357
NucleoMag Virus	1 x 96 plate kit	744800.1	\$ 771	\$ 463
NucleoMag Virus	4 x 96 plate kit	744800.4	\$ 2,867	\$ 1,720
NucleoBond RS- for high regulatory Standards				
NucleoBond RS 10	up to 10 mg	743502	\$ 1,122	\$ 673
NucleoBond RS 50	up to 50 mg	743503	\$ 1,075	\$ 645
NucleoBond RS 100	up to 100 mg	743504	\$ 2,067	\$ 1,240
NucleoBond RS 200	up to 200 mg	743505	\$ 3,676	\$ 2,206
Mini Plasmid Preparation				
NucleoSpin Plasmid (NoLid)	50	740499.50	\$ 218	\$ 131
NucleoSpin Plasmid (NoLid)	250	740499.250	\$ 775	\$ 465
NucleoSpin Plasmid	50	740588.50	\$ 218	\$ 131
NucleoSpin Plasmid	250	740588.250	\$ 969	\$ 581
NucleoSpin Plasmid EasyPure	50	740727.50	\$ 179	\$ 107
NucleoSpin Plasmid EasyPure	250	740727.250	\$ 756	\$ 454
NucleoSpin Plasmid Transfection-grade	50	740490.50	\$ 245	\$ 147
NucleoSpin Plasmid Transfection-grade	250	740490.250	\$ 1,080	\$ 648
96 well plate Plasmid Preparation kits				
NucleoSpin Plasmid Transfection-grade	1 x 96 plate kit	740491.1	\$ 893	\$ 536
NucleoSpin Plasmid Transfection-grade	24 x 96 plate kit	740491.24	\$ 15,094	\$ 9,056
NucleoSpin Plasmid Transfection-grade	4 x 96 plate kit	740491.4	\$ 2,895	\$ 1,737
NucleoSpin Plasmid Transfection-grade.Core	24 x 96 plate kit	740492.24	\$14,171	\$ 8,503
NucleoSpin Plasmid Transfection-grade.Core	4 x 96 plate kit	740492.4	\$ 2,706	\$ 1,624
NucleoBond 96 Xtra Endotoxin Free	1 x 96 plate kit	740430.1	\$ 1,730	\$ 1,038



NucleoBond 96 Xtra Endotoxin Free	4 x 96 plate kit	740430.4	\$ 5,552	\$ 3,331
Midi/Maxi Plasmid Preparation Endotoxin-Free				
PRODUCT	SIZE	CODE	LIST PRICE	PROMO PRICE
NucleoBond Xtra Midi EF	10	740420.10	\$ 348	\$ 209
NucleoBond Xtra Midi EF	50	740420.50	\$ 1,600	\$ 960
NucleoBond Xtra Midi Plus EF	10	740422.10	\$ 435	\$ 261
NucleoBond Xtra Midi Plus EF	50	740422.50	\$ 1,885	\$ 1,131
NucleoBond Xtra Maxi EF	10	740424.10	\$ 798	\$ 479
NucleoBond Xtra Maxi EF	50	740424.50	\$ 3,770	\$ 2,262
NucleoBond Xtra Maxi Plus EF	10	740426.10	\$ 889	\$ 533
NucleoBond Xtra Maxi Plus EF	50	740426.50	\$ 4,204	\$ 2,522
Midi/Maxi Plasmid Preparation				
NucleoBond Xtra Midi	10	740410.10	\$ 229	\$ 137
NucleoBond Xtra Midi	50	740410.50	\$ 1,047	\$ 628
NucleoBond Xtra Midi	100	740410.100	\$ 1,942	\$ 1,165
NucleoBond Xtra Midi Plus	10	740412.10	\$ 279	\$ 167
NucleoBond Xtra Midi Plus	50	740412.50	\$ 1,246	\$ 748
NucleoBond Xtra Maxi	10	740414.10	\$ 515	\$ 309
NucleoBond Xtra Maxi	50	740414.50	\$ 2,434	\$ 1,460
NucleoBond Xtra Maxi	100	740414.100	\$ 4,478	\$ 2,687
NucleoBond Xtra Maxi Plus	10	740416.10	\$ 579	\$ 347
NucleoBond Xtra Maxi Plus	50	740416.50	\$ 2,719	\$ 1,631
Mega/Giga Plasmid Preparation				
NucleoBond PC 2000 EF (Endotoxin Free), Mega kit	5 preps	740549	\$ 868	\$ 521
NucleoBond PC 2000, transfection-grade plasmid DNA, Mega kit	5 preps	740576	\$ 521	\$ 313
NucleoBond PC 10000 EF (Endotoxin Free), Giga kit	5 preps	740548	\$ 1,572	\$ 943
NucleoBond PC 10000, transfection-grade plasmid DNA, Giga kit	5 preps	740593	\$ 1,113	\$ 668
NucleoBond PC10000 Vaccum manifold (up to 5 columns)	1 piece	740599	\$ 1,643	\$ 986
Vaccum-based Plasmid Purification				
NucleoSnap Plasmid Mid	10	740494.10	\$ 298	\$ 179
NucleoSnap Plasmid Mid	50	740494.50	\$ 1,266	\$ 760
NucleoVac 24 Vaccum Manifold	1	740299	\$ 839	\$ 503
NucleoBond RS- for Large Scale plasmid purification for processes with high regulatory standards				
PRODUCT	THEORETICAL BINDING CAPACITY	CODE	LIST PRICE	PROMO PRICE
NucleoBond RS 10	up to 10 mg	743502	\$ 1,122	\$ 673
NucleoBond RS 50	up to 50 mg	743503	\$ 1,075	\$ 645



NucleoBond RS 100	up to 100 mg	743504	\$ 2,067	\$ 1,240
NucleoBond RS 200	up to 200 mg	743505	\$ 3,676	\$ 2,206

AAV vectors				
PRODUCT	SIZE	CODE	LIST PRICE	PROMO PRICE
AAVpro® Helper Free System (AAV1)	20 ug each	6673	\$ 2,712	\$ 1,763
AAVpro® Helper Free System (AAV2)	20 ug each	6230	\$ 2,712	\$ 1,763
AAVpro® Helper Free System (AAV5)	20 ug each	6650	\$ 2,712	\$ 1,763
AAVpro® Helper Free System (AAV6)	20 ug each	6651	\$ 2,712	\$ 1,763
AAV2 tetracycline-inducible expression system				
AAVpro® Tet-One™ Inducible Expression System (AAV2)	1 system	634310	\$ 2,961	\$ 1,925
Tet System Approved FBS, US sourced	500 mL	631101	\$ 2,736	\$ 1,778
Tet System Approved FBS	500 mL	631106	\$ 2,678	\$ 1,741
AAV2 CRISPR/Cas9 system				
PRODUCT	SIZE	CODE	LIST PRICE	PROMO PRICE
AAVpro® CRISPR/Cas9 Vector System	1 system	632609	\$ 1,523	\$ 990
AAVpro® CRISPR/Cas9 Helper Free System (AAV2)	1 system	632608	\$ 2,712	\$ 1,763
AAVpro® CRISPR/SaCas9 Helper Free System (AAV2)	1 system	632619	\$ 2,657	\$ 1,727
AAVpro® CRISPR/SaCas9 Vector System	1 system	632618	\$ 1,492	\$ 970
AAVpro Helper Free Systems (AAV-CRE Recombinase)				
AAVpro® Helper Free System (AAV1-CRE Recombinase)	20 ug each	6668	\$ 2,712	\$ 1,763
AAVpro® Helper Free System (AAV2-CRE Recombinase)	20 ug each	6652	\$ 2,712	\$ 1,763
AAVpro® Helper Free System (AAV5-CRE Recombinase)	20 ug each	6653	\$ 2,712	\$ 1,763
AAVpro® Helper Free System (AAV6-CRE Recombinase)	20 ug each	6654	\$ 2,712	\$ 1,763
Helper-virus free preparation of AAV-LacZ particles				
AAVpro® Helper Free System (AAV1-LacZ)	20 ug each	6669	\$ 2,712	\$ 1,763
AAVpro® Helper Free System (AAV2-LacZ)	20 ug each	6655	\$ 2,712	\$ 1,763
AAVpro® Helper Free System (AAV5-LacZ)	20 ug each	6656	\$ 2,712	\$ 1,763
AAVpro® Helper Free System (AAV6-LacZ)	20 ug each	6657	\$ 2,712	\$ 1,763
pAAV-ZsGreen1 Vector				
pAAV-ZsGreen1 Vector	20 ug	6231	\$ 1,778	\$ 1,156
Transfection Enhancer for AAV				
RevIT™	1.5 mL	MIR 8000	\$ 861	\$ 689
RevIT™	10 X 1.5 mL(10 L of cell culture)	MIR 8006	\$ 8,605	\$ 6,884



Packaging Systems and cells - 293T cells for AAV production				
AAVpro® 293T Cell Line	1 mL	632273	\$ 1,232	\$ 801
AAVpro packaging plasmid sets				
AAVpro® Packaging Plasmid (AAV1)	1 mg each	6672	\$ 3,200	\$ 2,080
AAVpro® Packaging Plasmid (AAV2)	1 mg each	6234	\$ 3,200	\$ 2,080
AAVpro® Packaging Plasmid (AAV5)	1 mg each	6664	\$ 3,200	\$ 2,080
AAVpro® Packaging Plasmid (AAV6)	1 mg each	6665	\$ 3,200	\$ 2,080
AAVpro® Extraction kits				
AAVpro® Extraction Solution	1 set	6235	\$ 534	\$ 347
AAVpro® Cell & Sup. Extraction/Concentration Pack Maxi (All Serotypes)	1 Kit(5 X T225 flasks)	6677	\$ 1,386	\$ 901
AAVpro® Freeze-Thaw Extraction Buffer (All Serotypes)	2 x 20 mL	6679	\$ 531	\$ 345
AAVpro® purification kits				
PRODUCT	SIZE	CODE	LIST PRICE	PROMO PRICE
AAV purification Kit Maxi (All Serotypes)	4 preps (5 X T225 flasks/prep)	6666	\$2,490	\$ 1,619
AAV purification Kit Midi (All Serotypes)	4 preps (1 X T225 flasks/prep)	6675	\$ 1,056	\$ 686
AAVpro® Cell & Sup. Purification Kit Maxi (All Serotypes)	4 preps (5 X T225 flasks/prep)	6676	\$ 2,918	\$ 1,897
AAVpro® Purification Kit (AAV2)	2 preps	6232	\$ 1,380	\$ 897
AAVpro® Purification Pack Maxi (All Serotypes)	4 preps (5 X T225 flasks/prep)	6678	\$ 1,535	\$ 998
AAVpro® Titration kits (for Real Time PCR)				
AAVpro® Titration kits (for Real Time PCR)	100 Rxns	6233	\$ 1,756	\$ 1,141
AAVpro® Concentrator				
AAVpro® Concentrator	1 kit(up to 150 mL of culture supernatant)	6674	\$ 1,295	\$ 842

Adeno-associated Virus Production				
VirusGEN AAV Transfection kits	1 kit for 1L of cell culture	MIR 6750	\$ 3,390	\$ 2,712
VirusGEN AAV + RevIT for 1L Culture	1 kit for 1L of cell culture	MIR 8007	\$ 3,390	\$ 2,712
TransIT-VirusGEN Transfection Reagent	30 mL	MIR 6720	\$ 23,275	\$ 18,620
TransIT-VirusGEN Transfection Reagent	10x1.5 mL	MIR 6706	\$ 13,615	\$ 10,892
TransIT-VirusGEN Transfection Reagent	1.5 mL	MIR 6700	\$ 1,701	\$ 1,361
TransIT-VirusGEN Transfection Reagent	0.75 mL	MIR 6704	\$ 1,074	\$ 859
TransIT-VirusGEN Transfection Reagent	0.30 mL	MIR 6703	\$ 426	\$ 341
TransIT-VirusGEN Transfection Reagent	5x 1.5 mL	MIR 6705	\$ 7,403	\$ 5,922



VirusGEN AAV + RevIT for 10L Culture	1 kit for 10L of cell culture	MIR 8008	\$ 26,554	\$ 21,243

Transfection Enhancer for AAV

RevIT™	1.5 mL	MIR 8000	\$ 861	\$ 689
RevIT™	10 X 1.5 mL(10 L of cell culture)	MIR 8006	\$ 8,605	\$ 6,884

Lentivirus Production

TransIT-VirusGEN Transfection Reagent	30 mL	MIR 6720	\$ 23,275	\$ 18,620
TransIT-VirusGEN Transfection Reagent	10x1.5 mL	MIR 6706	\$ 13,615	\$ 10,892
TransIT-VirusGEN Transfection Reagent	5x 1.5 mL	MIR 6705	\$ 7,403	\$ 5,922
TransIT-VirusGEN Transfection Reagent	1.5 mL	MIR 6700	\$ 1,701	\$ 1,361
TransIT-VirusGEN Transfection Reagent	0.75 mL	MIR 6704	\$ 1,074	\$ 859
TransIT-VirusGEN Transfection Reagent	0.30 mL	MIR 6703	\$ 426	\$ 341
TransIT-VirusGEN Transfection Kit	100 mL	MIR 6760	\$ 3,821	\$ 3,057

Vectors and Packaging

Adeno-X adenoviral system 3

PRODUCT	SIZE	CODE	LIST PRICE	PROMO PRICE
Adeno-X™ Adenoviral System 3 (CMV)	10 Rxns	632269	\$ 3,312	\$ 2,153
Adeno-X™ Adenoviral System 3 (CMV, Green)	10 Rxns	632267	\$ 3,801	\$ 2,471
Adeno-X™ Adenoviral System 3 (CMV, Red)	10 Rxns	632268	\$3,801	\$ 2,471
Adeno-X™ Adenoviral System 3 (Universal)	10 Rxns	632266	\$3,312	\$ 2,153
Adeno-X™ Adenoviral System 3 (Universal, Red)	10 Rxns	632265	\$ 3,801	\$ 2,471
Adeno-X™ Adenoviral System 3 (Universal, Green)	10 Rxns	632264	\$ 3,801	\$ 2,471
Adeno-X™ Adenoviral System 3 (Tet-On® 3G Inducible)	10 Rxns	631180	\$ 5,666	\$ 3,683

Tetracycline-inducible adenovirus system

Adeno-X™ Adenoviral System 3 (Tet-On® 3G Inducible)	10 Rxns	631180	\$5,666	\$ 3,683
Tet System Approved FBS	50 mL	631107	\$ 343	\$ 223
Tet System Approved FBS	500 mL	631106	\$2,678	\$ 1,741

293 cells for adenoviral packaging

Adeno-X™ 293 Cell Line	Each	632271	\$1,232	\$ 801
------------------------	------	--------	---------	---------------

Lenti Vectors

Constitutive promoter				
-----------------------	--	--	--	--



Lenti-X™ Bicistronic Expression System (Puro)	Each	632183	\$ 3,325	\$ 2,161
Lenti-X™ Bicistronic Expression System (Hyg)	Each	632182	\$ 3,325	\$ 2,161
Lenti-X™ Expression System (Neo)	Each	632181	\$ 3,325	\$ 2,161
Lenti-X™ Expression System	Each	632164	\$ 3,325	\$ 2,161
EF-1 alpha promoter				
pLVX-EF1alpha-DsRed-Monimer-C1	10 ug	631989	\$ 2,051	\$ 1,333
pLVX-EF1alpha-IRES-mCherry	10 ug	631987	\$ 2,051	\$ 1,333
pLVX-EF1alpha-mCherry-C1	10 ug	631985	\$ 2,051	\$ 1,333
pLVX-EF1alpha-AcGFP1-C1	10 ug	631984	\$ 2,051	\$ 1,333
pLVX-EF1alpha-AcGFP1-N1	10 ug	631983	\$ 2,051	\$ 1,333
pLVX-EF1alpha-IRES-ZsGreen1	10 ug	631982	\$ 2,051	\$ 1,333
Lenti-X™ Expression System (EF1alpha version)	10 ug	631253	\$ 3,325	\$ 2,161
IRES Vectors				
pLVX-IRES-tdTomato Vector	20 ug	631238	\$ 2,051	\$ 1,333
pLVX-IRES-mCherry Vector	20 ug	631237	\$ 2,051	\$ 1,333
pLVX-EF1alpha-mCherry-N1	10 ug	631986	\$ 2,051	\$ 1,333

Vectors with flourescent proteins				
PRODUCT	SIZE	CODE	LIST PRICE	PROMO PRICE
pLVX-PAmCherry-N1 Vector	10 ug	632586	\$ 2,102	\$ 1,366
pLVX-ZsGreen1-C1 Vector	10 ug	632566	\$ 2,051	\$ 1,333
pLVX-ZsGreen1-N1 Vector	10 ug	632565	\$ 2,051	\$ 1,333
pLVX-tdTomato-C1 Vector	10 ug	632564	\$ 2,051	\$ 1,333
pLVX-tdTomato-N1 Vector	10 ug	632563	\$ 2,051	\$ 1,333
pLVX-mCherry-N1 Vector	10 ug	632562	\$ 2,051	\$ 1,333
pLVX-mCherry-C1 Vector	10 ug	632561	\$ 2,051	\$ 1,333
pLVX-DsRed-Express2-N1 Vector	10 ug	632560	\$ 2,051	\$ 1,333
pLVX-DsRed-Express2-C1 Vector	10 ug	632559	\$ 2,051	\$ 1,333
pLVX-AmCyan1-N1 Vector	10 ug	632558	\$ 2,051	\$ 1,333
pLVX-AmCyan1-C1 Vector	10 ug	632557	\$ 2,051	\$ 1,333
pLVX-IRES-ZsGreen1 Vector	10 ug	632187	\$ 2,051	\$ 1,333
pLVX-AcGFP1-C1 Vector	10 ug	632155	\$ 2,051	\$ 1,333
pLVX-AcGFP1-N1 Vector	10 ug	632154	\$ 2,051	\$ 1,333
pLVX-DsRed-Monomer-C1 Vector	10 ug	632153	\$ 2,051	\$ 1,333
pLVX-DsRed-Monomer-N1 Vector	10 ug	632152	\$ 2,051	\$ 1,333
pLVX-IRES-tdTomato Vector	20 ug	631238	\$ 2,051	\$ 1,333
pLVX-IRES-mCherry Vector	20 ug	631237	\$ 2,051	\$ 1,333
Tet-One inducible expression systems				



Lenti-X™ Tet-One™ Inducible Expression System (Puro)	Each	631847	\$ 5,363	\$ 3,486
Lenti-X™ Tet-One™ Inducible Expression System	Each	631844	\$ 5,363	\$ 3,486
Tet System Approved FBS, US-Sourced	500 mL	631101	\$ 2,736	\$ 1,778
Tet System Approved FBS	500 mL	631106	\$ 2,678	\$ 1,741
Tet-On® 3G Inducible expression System				
Lenti-X™ Tet-On® 3G Inducible Expression System (EF1alpha Version)	Each	631363	\$ 5,363	\$ 3,486
Lenti-X™ Tet-On® 3G Inducible Expression System (EF1alpha, Bicistronic)	Each	631354	\$ 5,363	\$ 3,486
Lenti-X™ Tet-On® 3G Inducible Expression System (EF1alpha,ZsGreen1)	Each	631353	\$ 5,363	\$ 3,486
Lenti-X™ Tet-On® 3G Inducible Expression System (EF1alpha,mCherry)	Each	631352	\$ 5,363	\$ 3,486
Lenti-X™ Tet-On® 3G Inducible Expression System (Bicistronic Version)	Each	631351	\$ 5,363	\$ 3,486
Lenti-X™ Tet-On® 3G Inducible Expression System (with ZsGreen1)	Each	631350	\$ 5,363	\$ 3,486
Lenti-X™ Tet-On® 3G Inducible Expression System (with mCherry)	Each	631349	\$ 5,363	\$ 3,486
Lenti-X™ Tet-On® 3G Inducible Expression System	Each	631187	\$ 5,363	\$ 3,486

Lentivirus Packaging Systems				
PRODUCT	SIZE	CODE	LIST PRICE	PROMO PRICE
Lenti-X™ Packaging Single Shots (VSV-G)	16 Rxns	631275	\$ 3,133	\$ 2,036
Lenti-X™ Packaging Single Shots (Integrase Deficient)	16 Rxns	631277	\$ 3,133	\$ 2,036
Lenti-X™ Packaging Single Shots (VSV-G)	96 Rxns	631276	\$ 7,140	\$ 4,641
Lenti-X™ Packaging Single Shots (96-well, VSV-G)	4 x 96 well plates	631282	\$ 3,403	\$ 2,212
Lenti-X™ 293T Cell Line	1 mL	632180	\$ 1,232	\$ 801
Lentivirus Titration kits				
Lenti-X™ GoStix™ Plus	20 tests	631280	\$ 1,684	\$ 1,095
Lenti-X™ GoStix™ Plus	50 tests	631281	\$ 3,403	\$ 2,212
Lenti-X™ qRT-PCR Titration Kit	200 Rxns	631235	\$ 1,756	\$ 1,141
Lenti-X™ p24 Rapid Titer Kit(Single Wash)	96 Rxns	631476	\$ 2,023	\$ 1,315
Lenti-X™ p24 Rapid Titer Kit	96 Rxns	632200	\$ 2,023	\$ 1,315
Lenti-X Provirus Quantification Kit	200 Rxns	631239	\$ 1,756	\$ 1,141
Lentivirus Concentrator				
Lenti-X™ Concentrator	500 mL	631232	\$ 2,845	\$1,849
Lenti-X™ Concentrator	100 mL	631231	\$ 822	\$ 534
Lentivirus Integration site analysis				
Lentivirus Integration site analysis kit	Each	631263	\$ 2,958	\$ 1,923
Lentivirus purification kits				



Lenti-X™ Maxi purification kit	5 preps	631234	\$ 1,811	\$ 1,177
Lenti-X™ Maxi purification kit	2 preps	631233	\$ 949	\$ 617
Lentiviral Transduction Enhancers				
Lenti-X™ Accelerator	1 mL	631257	\$ 2,772	\$ 1,802
Lenti-X™ Accelerator	0.4 mL	631256	\$ 1,395	\$ 907
Lenti-X™ Accelerator Starter Kit	Each	631254	\$ 3,434	\$ 2,232
Ecotropic Receptor Booster	20 Rxns	631471	\$ 1,028	\$ 668
Retro-X™ Universal Packaging System	Each	631530	\$ 2,854	\$1,855
RetroNectin®- Transduction enhancer				
RetroNectin® Precoated Dish	10 Dishes	T110A	\$ 1,289	\$ 838
RetroNectin® Recombinant Human Fibronectin Fragment	2.5 mg	T100B	\$ 2,575	\$ 1,674
RetroNectin® Recombinant Human Fibronectin Fragment	0.5 mg	T100A	\$ 695	\$ 452
RetroNectin® GMP grade	2.5 mL	T202	\$ 5,427	\$ 3,528

Whole-Cell Labeling (flourescent Lenti particles)				
rLV.EF1.ZsYellow1-9	1 x 20 uL	0040VCT	\$ 2,433	\$ 1,581
rLV.EF1.AmCyan1-9	1 x 20 uL	0039VCT	\$ 2,433	\$ 1,581
rLV.EF1.ZsGreen1-9	1 x 20 uL	0038VCT	\$ 2,433	\$ 1,581
rLV.EF1.mCherry-9	1 x 20 uL	0037VCT	\$ 2,433	\$ 1,581
rLV.EF1.tdTomato-9	1 x 20 uL	0036VCT	\$ 2,433	\$ 1,581
rLV.EF1.ZsYellow1-9	3 x 20 uL	0012VCT	\$ 6,604	\$ 4,293
rLV.EF1.AmCyan1-9	3 x 20 uL	0011VCT	\$ 6,604	\$ 4,293
rLV.EF1.ZsGreen1-9	3 x 20 uL	0010VCT	\$ 6,604	\$ 4,293
rLV.EF1.mCherry-9	3 x 20 uL	0009VCT	\$ 6,604	\$ 4,293
rLV.EF1.tdTomato-9	3 x 20 uL	0008VCT	\$ 6,604	\$ 4,293

Specific Subcellular Organelle Labelling(flourescent Lenti particles)				
rLV.EF1.mCherry-ER-9	3 x 20 uL	0025VCT	\$ 6,604	\$ 4,293
rLV.EF1.mCherry-Mito-9	3 x 20 uL	0024VCT	\$ 6,604	\$ 4,293
rLV.EF1.mCherry-Nuc-9	3 x 20 uL	0023VCT	\$ 6,604	\$ 4,293
rLV.EF1.mCherry-Golgi-9	3 x 20 uL	0022VCT	\$ 6,604	\$ 4,293
rLV.EF1.mCherry-Tubulin-9	3 x 20 uL	0021VCT	\$ 6,604	\$ 4,293
rLV.EF1.mCherry-Actin-9	3 x 20 uL	0020VCT	\$ 6,604	\$ 4,293
rLV.EF1.AcGFP1-Mem-9	3 x 20 uL	0019VCT	\$ 6,604	\$ 4,293
rLV.EF1.AcGFP1-Endo-9	3 x 20 uL	0018VCT	\$ 6,604	\$ 4,293
rLV.EF1.AcGFP1-Mito-9	3 x 20 uL	0017VCT	\$ 6,604	\$ 4,293
rLV.EF1.AcGFP1-Nuc-9	3 x 20 uL	0016VCT	\$ 6,604	\$ 4,293
rLV.EF1.AcGFP1-Golgi-9	3 x 20 uL	0015VCT	\$ 6,604	\$ 4,293
rLV.EF1.AcGFP1-Tubulin-9	3 x 20 uL	0014VCT	\$ 6,604	\$ 4,293
rLV.EF1.AcGFP1-Actin-9	3 x 20 uL	0013VCT	\$ 6,604	\$ 4,293



Tet-On 3G transactivator lentiviral particles				
rLV.EF1.Tet3G-9	1 x 20 u	0055VCT	\$ 2,433	\$ 1,581
rLV.EF1.Tet3G-9	3 x 20 uL	0027VCT	\$ 6,604	\$ 4,293
Tet System Approved FBS, US-Sourced	500 mL	631101	\$ 2,736	\$ 1,778

Retroviral Vectors				
Constitutive Gene expression				
Retro-X™ Q Vector Set	4 x 20 ug	631516	\$ 1,817	\$ 1,181
pQCXIX Retroviral Vector	20 ug	631515	\$ 1,320	\$ 858
pQCXIN Retroviral Vector	20 ug	631514	\$ 1,320	\$ 858
LRCX Retroviral Vector Set	Each	631511	\$ 1,671	\$ 1,086
pLXSN Retroviral Vector	20 ug	631509	\$ 1,274	\$ 828
pLNXC2 Retroviral Vector	20 ug	631503	\$ 1,274	\$ 828
pLXIN Retroviral Vector	20 ug	631501	\$ 1,274	\$ 828
pDON-5 DNA	20 ug	3658	\$ 1,229	\$ 799
pDON-5 Neo DNA	20 ug	3657	\$ 1,229	\$ 799
pMEI-5 DNA	20 ug	3656	\$ 1,229	\$ 799
pMEI-5 Neo DNA	20 ug	3655	\$ 1,229	\$ 799
pDON-AI-2 DNA	20 ug	3654	\$ 1,229	\$ 799
pDON-AI-2 Neo DNA	20 ug	3653	\$ 1,229	\$ 799

Flourescent protein Vectors				
pRetroQ-mCherry-N1 Vector	10 ug	632568	\$ 1,723	\$ 1,120
pRetroQ-mCherry-C1 Vector	10 ug	632567	\$ 1,723	\$ 1,120
pRetroX-IRES-DsredExpress Vector	20 ug	632521	\$ 1,723	\$ 1,120
pRetroX-IRES-ZsGreen1 Vector	20 ug	632520	\$ 1,723	\$ 1,120
pRetroQ-DsRed Monomer-C1 Vector	20 ug	632508	\$ 1,723	\$ 1,120
pRetroQ-DsRed Monomer-N1 Vector	20 ug	632507	\$ 1,723	\$ 1,120
pRetroQ-AcGFP1-C1 Vector	20 ug	632506	\$ 1,723	\$ 1,120
pRetroQ-AcGFP1-N1 Vector	20 ug	632505	\$ 1,723	\$ 1,120

Retro-X Tet-One Inducible expression systems				
Retro-X™ Tet-One™ Inducible Expression System (Puro)	Each	634307	\$ 4,847	\$ 3,151
Tet System Approved FBS, US-Sourced	500 mL	631101	\$ 2,736	\$ 1,778
Tet System Approved FBS	500 mL	631106	\$ 2,678	\$ 1,741

Retro-X Tet-On® 3G Inducible expression systems				
Retro-X™ Tet-On® 3G Inducible Expression System	Each	631188	\$ 4,847	\$ 3,151

MSCV system				
MSCV Retroviral Expression System	Each	634401	\$ 2,408	\$ 1,565

Retrovirus Packaging Systems				
------------------------------	--	--	--	--



Retro-X™ Universal Packaging System	Each	631530	\$ 2,854	\$ 1,855
Pantropic Retroviral Expression System	Each	631512	\$ 2,854	\$ 1,855
RetroPack™ PT67 Cell Line	1 mL	631510	\$ 2,718	\$ 1,767
Retro-X™ System	Each	631508	\$ 2,393	\$ 1,555

Retrovirus Titration kits (for Real Time PCR)				
Retro-X™ qRT-PCR Titration Kit	200 Rxns	631453	\$ 1,756	\$ 1,141
Retrovirus Concentrator				
Retro-X™ Concentrator	500 mL	631456	\$ 2,845	\$ 1,849
Retrovirus Integration kit				
Retro-X™ Integation Site Analysis Kit	Each	631467	\$ 2,958	\$ 1,923
Retroviral Transduction Enhancers				
Ecotropic Receptor Booster	20 Rxns	631471	\$ 1,028	\$ 668
Retro-X™ Universal Packaging System	Each	631530	\$ 2,854	\$ 1,855
RetroNectin®- Transduction enhancer				
RetroNectin® Precoated Dish	10 Dishes	T110A	\$ 1,289	\$ 838
RetroNectin® Recombinant Human Fibronectin Fragment	2.5 mg	T100B	\$ 2,575	\$ 1,674
RetroNectin® Recombinant Human Fibronectin Fragment	0.5 mg	T100A	\$ 695	\$ 452
RetroNectin® GMP grade	2.5 mL	T202	\$ 5,427	\$ 3,528

Astrea Bio High Purity Bioprocessing Adsorbents

Please contact us for competitive pricing

PRODUCT	SIZE	CODE
Butyl PuraBead® HF	100mL	3416-00100
Butyl PuraBead® HF	1L	3416-01000
Butyl PuraBead® HF	25mL	3416-00025
Butyl PuraBead® HF	500mL	3416-00500
Butyl PuraBead® HF Pre-packed Column	Pre-packed Column - 1 x 1 mL	6734
Butyl PuraBead® HF Pre-packed Column	Pre-packed Column - 1 x 5 mL	6735
Butyl PuraBead® HF Pre-packed Column	Pre-packed Column - 4 x 1 mL	6634
Butyl PuraBead® HF Pre-packed Column	Pre-packed Column - 4 x 5 mL	6635
Hexyl PuraBead® HF	100mL	3426-00100
Hexyl PuraBead® HF	1L	3426-01000
Hexyl PuraBead® HF	25mL	3426-00025
Hexyl PuraBead® HF	500mL	3426-00500
Hexyl PuraBead® HF Pre-packed Column	Pre-packed Column - 1 x 1 mL	6736



Hexyl PuraBead® HF Pre-packed Column	Hexyl PuraBead® HF Pre-packed Column - 1 x 5 mL	6737
Hexyl PuraBead® HF Pre-packed Column	Pre-packed Column - 4 x 1 mL	6636
Hexyl PuraBead® HF Pre-packed Column	Pre-packed Column - 4 x 5 mL	6637
HIC Selection Kit	4 x 1 mL	6614
HIC Selection Kit	4 x 5 mL	6615
Octyl PuraBead® HF	100mL	3455-00100
Octyl PuraBead® HF	1L	3455-01000
Octyl PuraBead® HF	25mL	3455-00025
Octyl PuraBead® HF	500mL	3455-00500
Octyl PuraBead® HF Pre-Packed Column	Pre-Packed Column - 1 x 1 mL	6712
Octyl PuraBead® HF Pre-Packed Column	Pre-Packed Column - 1 x 5 mL	6713
Octyl PuraBead® HF Pre-Packed Column	Pre-Packed Column - 4 x 1 mL	6612
HCPure™		
HCPure™	25 mL	3260-00025
HCPure™	100 mL	3260-00100
HCPure™	500 mL	3260-00500
HCPure™	1L	3260-01000
Q PuraBead®		
CM PuraBead® HF Pre-packed Columns	1 x 1 mL	6706
CM PuraBead® HF Pre-packed Columns	1 x 5 mL	6707
CM PuraBead® HF Pre-packed Column	4 x 1 mL	6606
CM PuraBead® HF Pre-packed Columns	4 x 5 mL	6607
CM PuraBead® P6HF	1L	3450-01000
CM PuraBead® P6HF	100 mL	3450-00100
CM PuraBead® P6HF	25 mL	3450-00025
CM PuraBead® P6HF	500 mL	3450-00500
DEAE PuraBead® HF	100 mL	3451-00100
DEAE PuraBead® HF	1L	3451-01000
DEAE PuraBead® HF	25 mL	3451-00025
DEAE PuraBead® HF	500 mL	3451-00500
DEAE PuraBead® HF Pre-packed Column	1 x 1 mL	6702
DEAE PuraBead® HF Pre-packed Columns	1 x 5 mL	6703
DEAE PuraBead® HF Pre-packed Columns	4 x 1 mL	6602
DEAE PuraBead® HF Pre-packed Columns	4 x 5 mL	6603
IEX Selection Kit	4 x 1 mL	6608
IEX Selection Kit	4 x 5 mL	6609
Q PuraBead® HF	100 mL	3452-00100
Q PuraBead® HF	1L	3452-01000
Q PuraBead® HF	25 mL	3452-00025
Q PuraBead® HF	500 mL	3452-00500



Q PuraBead® HF Pre-packed Columns	1 x 1 mL	6700
Q PuraBead® HF Pre-packed Columns	1 x 5 mL	6701
Q PuraBead® HF Pre-packed Columns	1 x 5 mL	6600

LentiHERO

LentiHERO®- lentiviral vector purification		
LentiHERO® 1	1 mL	LH0002001A
LentiHERO® 10	10 mL	LH0010001B
Nereus Spin Column	1 column	NL100100-new

pDNAHERO® 1 polish		each	PHP0001001A
pDNAHERO® 10 polish		each	PHP0001001B

T&C's Apply. Promotional price valid from May 1st to July 31st 2024.

All prices exclude GST and freight charges will apply.

Prices subjected to change without notice.

Please contact Scientifix for more product information, pricing or to request a quote

For customer service, call 1800 007 900 or email info@scientifix.com.au

More information visit www.scientifix.com.au